



CARTECK AUTOMATIC.

The smart technology garage door for your home.





WHERE TO BEGIN?!

1 STRONG & MORE SECURE  Page 4

2 KEEP THE ELEMENTS AT BAY  Page 6

3 EASIER PARKING, MORE SPACE  Page 8

4 SMART TECHNOLOGY OPENERS  Page 10

5 MADE TO MEASURE, MADE TO LAST  Page 14

6 MAXIMUM SAFETY & PERFORMANCE  Page 16

7 THE STYLES  Page 18

8 STYLE OPTIONS - WINDOWS & BLING  Page 28

8 GOOD REASONS FOR A

9 SLX & GSA VISION  Page 32

Looking for something different?

10 CARTECK SIDE HINGED  Page 36



Making the garage part of your home

Garages are often draughty, cold and uninviting spaces and opening a tilting garage door can be a shin cracking chore. CarTeck Automatic changes everything.

CarTeck Automatic is a design and precision engineering led garage door. Wonderful architect grade finishes and styling are married with certified thermal performance.

Operation is by an integrated smart technology remote control motor, the CarTeck Drive.

Opening your door becomes effortless, safe and secure. It brings your garage back to being part of your home.

Explore the pages ahead to see why CarTeck Automatic is...

Harmony in motion.



CARTECK AUTOMATIC DOOR



HEAVY METAL?
NOTHING
EASIER THAN
THAT!

STRONG & MORE SECURE

Even easy riders are impressed! Thanks to a high-quality steel core and durable multiple coating, our sectional door panels withstand the toughest conditions. TÜV-certified quality ensures top marks for safety and durability. Our CarTeck garage doors are tough as steel and meet the heavy-duty demands for everyday use.

Once inside you can rest easy too - CarTeck Automatic is very strong and designed for burglary resistance, keeping your possessions safe and protecting any access doors into your home.

The doors' physical strength characteristics are an impressive barrier and CarTeck Automatic's opener adds a further layer of security.



The opener actively monitors the door and, if any attempt is made to force the door up, the motor engages and pushes back with a 60kg force!

Add our extra-security pack and the magnetic motor lock mechanically locks the motor in any position up to an impressive 300kg of force. The pack also adds an alarm buzzer that recognises a break-in attempt and outputs a loud deterrent signal tone.

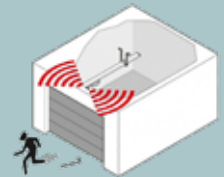



HEAVY WEATHER? WARM, DRY & FEWER DRAUGHTS!

WARM, DRY & FEWER DRAUGHTS

Garages can be dust blown, cold, draughty and damp places. CarTeck Automatic is designed to bring your garage back into your home.

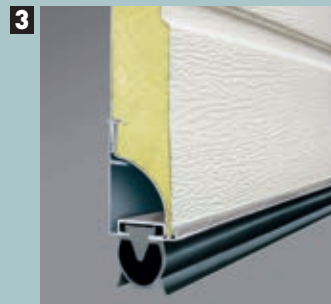
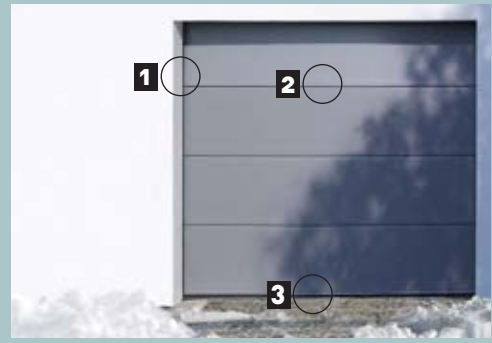

WEATHER PROTECTION

Bottom, side, top and inter-panel weather protection keeps out the elements and lowers energy use.

WHAT PERFORMANCE CAN I EXPECT?

As part of the CE marking process, each product must have its performance provided for a defined set of characteristics to allow fair comparison between products from different manufacturers. Other characteristics can also be included, if relevant to a door's performance. The following table shows the performance characteristics of CarTeck sectional garage doors.

PERFORMANCE CHARACTERISTIC

RATING

| | |
|---|------------------------------|
| Resistance to Windload EN 12424 | Class 2 |
| Watertightness EN 12425 | Class 2 |
| Air Permeability EN 12426 | Class 2 |
| Thermal Transmittance EN 13241 | 1.38 W/m²k |
| Operating Forces (hand Operated) EN 12604 | 150 N |

INSULATION 'U VALUE'

What's in a number? Our 40mm thick panels have an insulating value that has been independently tested to 0.56 W/m²K. The lower the value the better the insulating properties.

It's not a figure we tend to quote because we know a door is more than just a panel. We quote the

insulation value for a complete door (8'0" wide x 7'0" high) including the panel joints and weather strips. CarTeck Automatic has an insulation 'U value' of 1.38 W/m²K - you won't find better performance on any comparable garage door.

THE ELEMENTS AT BAY!

TECKENTRUP
DOOR SOLUTIONS

EASIER PARKING & BETTER USE OF SPACE



OPERATIONAL SAFETY, NEAT & HIDDEN AWAY



Springs are concealed high up in the top tray - safely away from little fingers. Unsightly, open torsion springs are history. CarTeck trays also keep the springs in pristine condition, ensuring long-term smooth and quiet operation.



FLEXIBLE USE OF SPACE

Vertical opening means CarTeck Automatic fits all shapes of garage opening and even in garages with very little headroom.



EASIER PARKING

There's no denying cars are wider and taller than they used to be. Unlike old design up and over doors, CarTeck Automatic fits behind the garage opening typically adding up to 150mm to the width and at 75mm to the height - stress free parking is the result!



Before...



...After!

BETTER USE OF SPACE

CarTeck sectional doors travel vertically with no out-swing allowing you to make the most of the parking space on the drive and inside the garage.



Maximum clearance

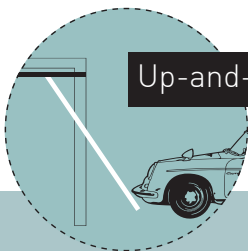

Up-and-over door



Sectional door



Up... out... and over... No thanks!



...Park as close as you like!

SIMPLE, SO EFFECTIVE

TECKENTRUP
DOOR SOLUTIONS

CarTeck DRIVE^{CE}

HEAVY WORK?
EFFORTLESS,
INTEGRATED &
SMART

MAKING THINGS EASIER

CarTeck Automatic makes so much sense. The fixed chain drive of the CarTeck Drive range is quieter and renowned for long-term reliability compared to revolving chain or belt designs.

CE Our doors and openers are independently tested and certified to all current safety legislation and carry a CE mark.

CARTECK DRIVE 500 600

The integrated drive and control unit of the CarTeck DRIVE 500 and 600 fits discreetly above the door.

Both the DRIVE 500 and the 600 can lift any size door. The 600 is available with all the option packs and the 500 is available with selected options - see page 12-13.

See the table right for a specification overview of each model.



Motor light on DRIVE 500 & 600

| | POWER | TRANSMITTERS | SPEED | LIGHTING | OPTIONS |
|-----------|-------|----------------|--------------------|-----------------------|-------------------------------------|
| DRIVE 500 | 500Nm | 2 x Pearl Twin | 180mm/sec ▶▶▶ | 1 x 3 LED Motor Light | Selected option packs see pg. 12-13 |
| DRIVE 600 | 600Nm | 2 x Pearl | 240mm/sec ▶▶▶▶▶ | 1 x 6 LED Motor Light | All option packs see pg. 12-13 |

Harmony in motion
SMART SOLUTIONS



CARTECK DRIVE PRO 500 600

The separate control unit of the CarTeck DRIVE PRO 500 and 600 allows for flexible installation at a location close to available power sockets.

Both the DRIVE PRO 500 and the 600 can lift any size door. The 600 is available with all the option packs and the 500 is available with selected options - see page 12-13.

See the table below for a specification overview of each model.



DRIVE PRO 500 or 600 low level front mounted control



DRIVE PRO 500 or 600 ceiling mounted control



DRIVE PRO 500 or 600 low level rear mounted control



Motor light on PRO 500 & 600



PRO 600 Control Unit

| | POWER | TRANSMITTERS | SPEED | LIGHTING | OPTIONS |
|---------------|-------|----------------|--------------------|-----------------------|-------------------------------------|
| DRIVE PRO 500 | 500Nm | 2 x Pearl Twin | 180mm/sec ▶▶▶ | 1 x 3 LED Motor Light | Selected option packs see pg. 12-13 |
| DRIVE PRO 600 | 600Nm | 2 x Pearl | 240mm/sec ▶▶▶▶▶ | 1 x 6 LED Motor Light | All option packs see pg. 12-13 |

PEARL TWIN

The Pearl Twin transmitter has twin buttons that can be configured for two functions such as open and close and turn on the light.



Pearl Twin transmitter

PEARL

The Pearl transmitter has four buttons that can be configured to suit your requirements - open and close, turn on the light, operate a second door and so on.



Pearl transmitter

SMART TRANSMITTERS

COMPLEMENTARY CONTROL

CarTeck DRIVE⁺

Our function packs place you in control. Clever technology takes the guess work out of parking, keeps your garage dry, lights your way and keeps you moving even if power fails.

PARKING PACKS

A laser sensor to guide you to the perfect parking point combines with a humidity sensor. If you drive your car in wet and the humidity in the garage rises, the sensor automatically opens the door a short distance to allow fresh air in, helping prevent mould forming. When humidity levels drop, the sensor automatically closes the door.

PARKING PACK 1 ●

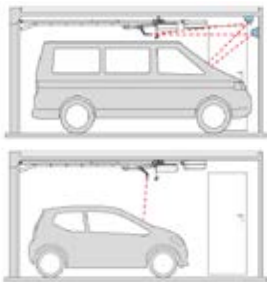

Laser & reflector

PARKING PACK 2 ●



Humidity Sensor

POWER PACK ●

A simple battery backup for power failure operation. The battery module assumes the power supply of the operator for up to 5 door cycles.



Battery

SAFETY PACK ○

Add non-contact obstruction detection with Photoeye that uses an infra-red light beam across the opening to stop the door when the beam is broken.

Photoeye



AMBIENCE PACK 1 ●

Need more light? Extra lighting strips for the control units can be combined with the motion sensor to switch on automatically as you enter. No more crashing about in the dark!

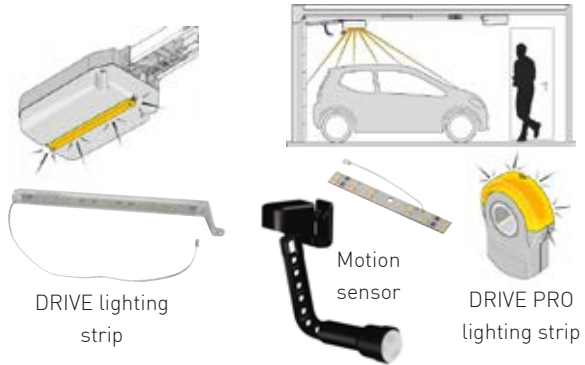

DRIVE lighting strip

Motion sensor

DRIVE PRO lighting strip

AMBIENCE PACK 2 ○

Add a relay to allow control of other garage or garden lighting for even more flexibility.



Relay



AMBIENCE PACK 3 ○

These clever LED strips are easily positioned on the underside of the door tracks with magnetic tape. They flood the garage with 6000 lumens of light (equivalent to around 400 watts of incandescent light!) Four linked LED strips are activated by the kits' motion sensor or infra red remote control.

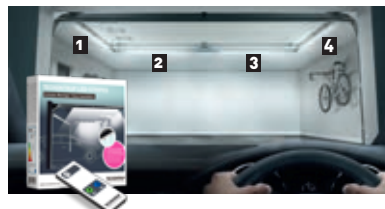

AMBIENCE PACK 4 ○

Add light bars to the outside of your garage to make a real design statement whilst increasing accessibility and safety at night. The light bar has a stand-alone power supply and motion detector. The light is 1500 lumen per metre and has neutral white 4000K light.



KEY

AVAILABLE FOR:
 DRIVE / DRIVE PRO 500 ○
 DRIVE / DRIVE PRO 600 ●

Harmony in motion

SMART SOLUTIONS

L, SO CLEVER...

SECURITY PACK 1

A magnetic motor lock that mechanically locks the motor in any position (even with ventilation function) up to an attack force of 300 kg, increasing the existing security.

The alarm buzzer recognises a break-in attempt and outputs a loud signal tone. The warning buzzer outputs an acoustic signal as the door closes.

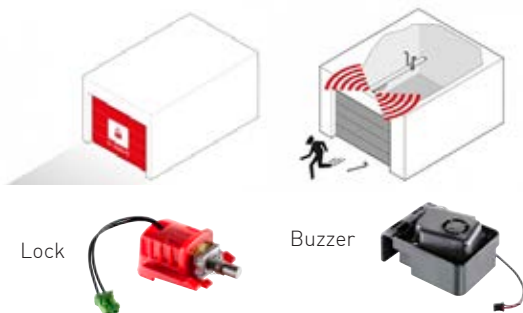

Lock

Buzzer

ACCESS PACK 1

If you don't want to carry a transmitter you can operate your door from a wall mounted outdoor keypad. It's the perfect solution if you're out cycling or for family members that use the door occasionally. The courier function offers you a simple and safe and solution for receiving parcels into your garage.



Keypad

ACCESS PACK 2

For extra convenience you can control your door and check its position from within your home with a two function wall switch available in grey or white finish. Similar in size to a standard single light switch.



Wall Switch

ACCESS PACK 3

Add a wireless keypad with sleek stainless steel trim and back lighting for easy transmitter-free access to your garage. The surface-mounted keypad is battery operated making it the perfect solution for retrofitting. The keypad also has flexible usage options - multiple codes and the ability to control up to five different functions, such as garage door and lighting, etc.



Keypad

SECURITY PACK 2

A relay that allows control of other garage or garden / security lighting.

The alarm buzzer recognises a break-in attempt and outputs a loud signal tone. The warning buzzer outputs an acoustic signal as the door closes.

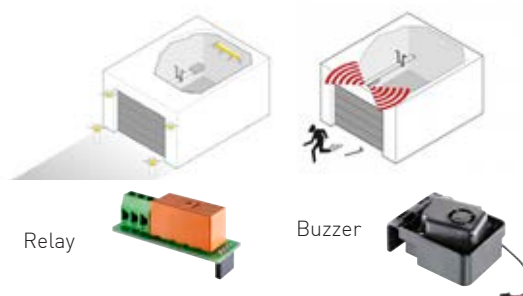

Relay

Buzzer

TRANSMITTERS

Adding additional transmitters is simple - choose Pearl Twin or Pearl transmitters (see page 11) or the bidirectional capability of the Pearl Vibe, below.

THE PEARL VIBE

The Pearl Vibe transmitter option vibrates in your hand confirming that the control unit has received your command. It can also confirm if your door is open or closed using bidirectional communication between the opener and transmitter.



Pearl Vibe with bidirectional communication

SMART PACK

The Output module transfers the door status (open/closed) allowing you to integrate your garage into Smart Home systems.



Output

SOMWEB SMART PHONE CONTROL

The secure SOMweb Smart Home solution where your data stays safely inside your garage! Our system enables you to control your garage door via a smartphone app or web browser. Meanwhile, your data is kept safe, as it is not stored on external servers.



PLACING YOU IN CONTROL!

TECKENTRUP
DOOR SOLUTIONS

MADE TO MEASURE MADE TO LAST

SUPERB MANUFACTURING

Our door leaves compromise eight different layers, which gives them extraordinary wear resistance and durability.

- a** Sealed top coating
- b** Highly effective adhesion primer
- c** Corrosion-resistant galvanized
- d** Steel core
- e** Corrosion-resistant galvanized
- f** Highly effective adhesion primer
- g** Protective coat on rear side
- h** Highly-stable core made of special foam with integrated thermal insulation

Whether you have a new garage or you're updating the look of your home, choosing quality protects the value of your home – for tomorrow and the generations to come.

As a family business, we see things in the same light. Only a solution that retains its value for years is really a good investment - CarTeck Automatic



MATCHED FRAMES

A simple one, but overlooked by many other garage door companies. Teckentrup doors all have colour matching frames, giving your new door serious kerb-appeal.

ROBUST & DURABLE

CORROSION PROTECTION

A special plastic element separates the vertical frame sections from the floor. Whether after a rain shower or in the case of creeping dampness - the design ensures that the base area is always aerated, dries quickly, and is hence better protected against corrosion.



DURABLE SURFACE PROTECTION

The galvanized garage door frames have a high-quality top coating. This protects the doors from external influences and they remain just as decorative after several years as they were on the first day, with just a little regular care and maintenance.



0mm Bottom Profile

EXACT FIT DIMENSIONS

Whether you're renovating or building anew - Teckentrup sectional garage doors fit perfectly into every installation situation. Door widths of up to 5.5m and door heights of up to 3m are made to measure for the right fit. Every door is superbly manufactured to exacting standards.

To achieve a door height, Teckentrup uses a mix of different panel heights and different depth bottom profiles of 0mm, 7mm, 17mm & 32mm.



32mm Bottom Profile

This image shows the 32mm bottom profile compared to the 0mm bottom profile shown in the image above.

MAINTENANCE

Doors must be maintained as per the supplied Installation, Operating and Maintenance Manual by a Garage Door Specialist. Failure to carry out the required maintenance at the advised interval will invalidate the warranty.

CLEANING ON INSTALLATION

After the installation has been completed, clean and dry the door thoroughly inside and out with warm soapy water to remove any grease, dust and metal fragments from the door (these will discolour the door finish if left on the door).

CLEANING

The door should be washed with a car shampoo or similar, every two months, to prevent the build up of dirt, salt, grit and other corrosive substances. If the door is in an area prone to coastal corrosion from airborne salts, the door should be cleaned monthly. Furthermore, cleaning lifting gear with a cloth soaked in a light oil will help to protect your door from corrosion – it must be accepted that salt air is very aggressive and extra care is required.

No caustic, abrasive or corrosive chemicals and substances, flood water, water runoff, or runoff from lead, copper or galvanic metal flashing should be allowed to come into contact with the door.

Ash, cement, dust, animal waste, or foreign substances should be removed immediately. Failure to ensure the door is cleaned and maintained as described will invalidate the doors' warranty.





SAFETY ABOVE ALL

Safe operation of CarTeck Automatic is the overriding priority of every design decision we make. Precise manufacturing tolerances ensure quality is high and long-term reliability and durability is inherent, which in turn maintains safety.



FINGER SAFE & HAND PROTECTION

The patented finger pinch protection at panel joints protects you from injury. Protection at the side of the door prevents a hand from being accidentally caught between the frame and guide rail.



QUIET DOOR OPERATION

Innovative designs worked out in great detail, such as rollers made from special plastic, ensure quiet opening and closing. Rattling door movements are a thing of the past.



Our doors and openers are independently tested and certified to all current safety legislation and carry a CE mark.

MAXIMUM



CONCEALED SPRINGS

Where is the best and safest place for springs? One place - concealed and enclosed, high up in top trays, safely away from fingers. The trays also keep the springs in pristine condition, ensuring long-term smooth and quiet operation.

Concealed springs shown from above with the covers removed.

- Safe, concealed springs
- Visible, dust traps and potentially within reach of inquisitive little fingers

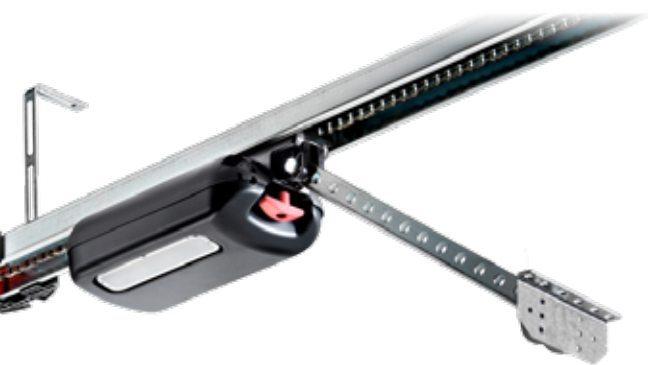
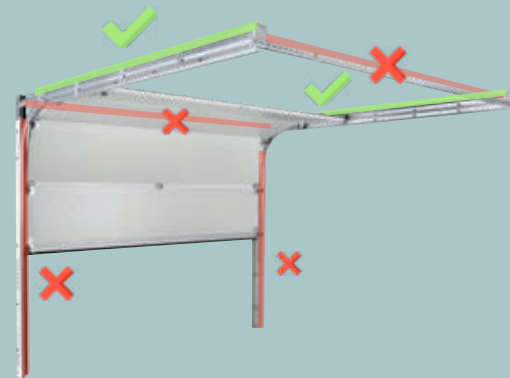

6 POINT GUARANTEE

The warranty periods below only apply to products that have been correctly installed as per the instructions, maintained by a Garage Door Specialist and operated and cleaned in accordance with the requirements set out in the operating and maintenance sections of instructions and labels.

2-year manufacturer's guarantee

- on polymer and aluminium window units

5-year manufacturer's guarantee

- on rollers, hinges, cable pulleys, cables and standard springs (opening/closing max. 5 times a day)

10-year manufacturer's guarantee

- on panels against rust penetration from inside to outside
- against door panel separation of steel from foam
- on material and manufacturing flaws of all non-moving parts of the frame that are verifiably unusable or whose usability is substantially compromised
- on floor seal, intermediate seals, side seals and lintel seal against rotting

The guarantee does not apply to doors that are subjected to extreme conditions, e.g. corrosive influences resulting from use in a coastal climate with high salt content.

SAFETY SENSING



The motor control units' safety circuits monitor force levels many times every second. If the door encounters an obstruction, it is instantly sensed and the motor stops and reverses a short distance.

EXTERNAL RELEASE

In the event of power failure, the motor can be disengaged using the discreet external release. This should be fitted if no alternative access to the garage is available to allow manual operation of the door until power returns.

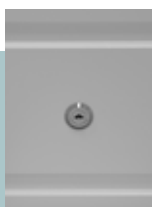

Terms & conditions apply - see: www.teckentrupdepot.co.uk



SAFETY & PERFORMANCE

The Modern Master

Simple, clean design sets apart the CarTeck Automatic Solid as the contemporary choice.

CarTeck Automatic Solid

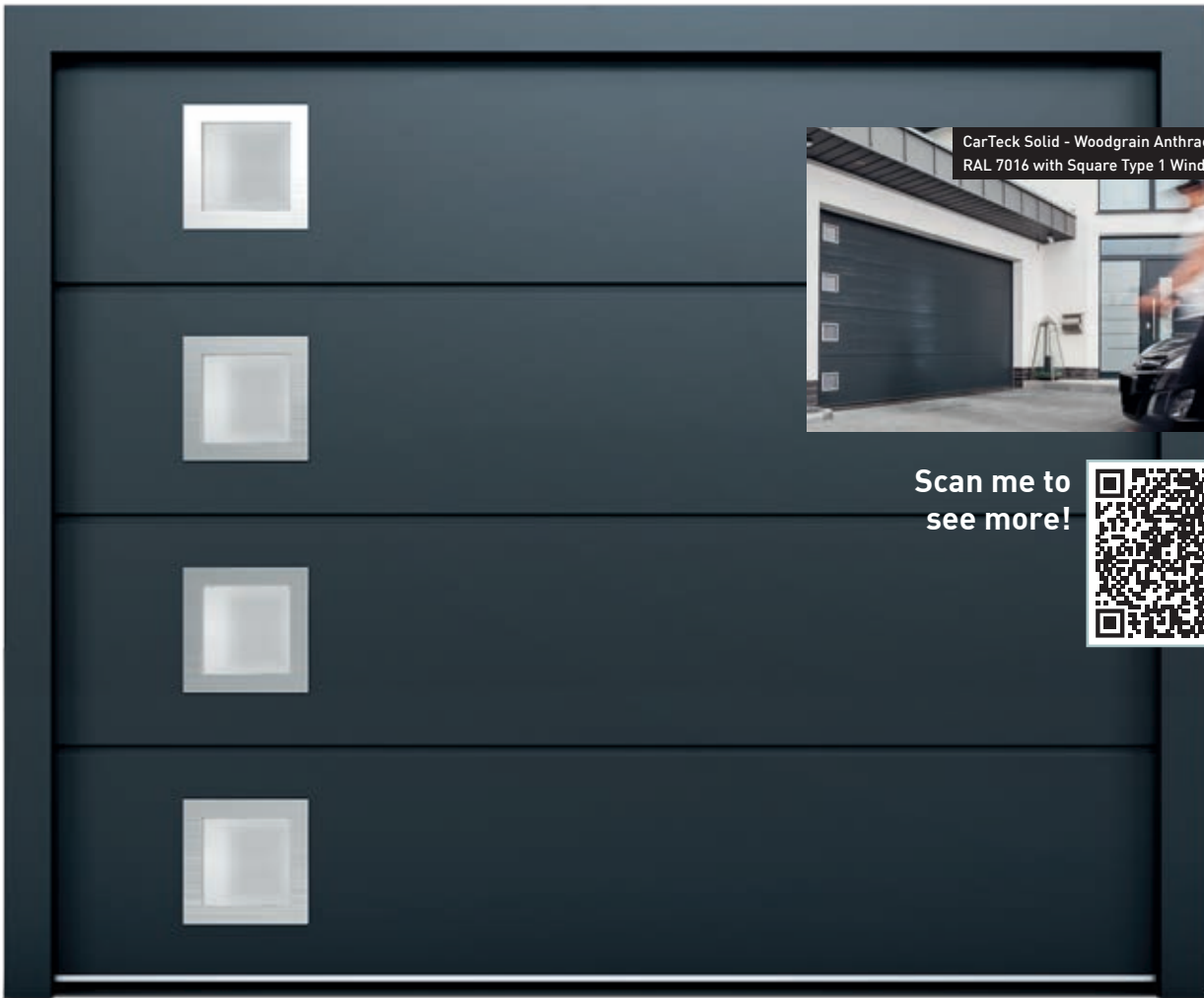

CarTeck Solid - Woodgrain Anthracite Grey RAL 7016 with Square Type 1 Windows

Scan me to see more!



CarTeck Solid - Smooth Anthracite Grey RAL 7016 with Alpha Windows

Surface Textures



Smooth



Woodgrain



Stucco

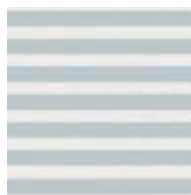

Micro-profiled

A note about colour

Where doors are exposed to direct sunlight, dark colours should be avoided.

RAL references for colours are provided as a guide only to the nearest similar RAL colour. Colours will not match to other RAL finishes due to different coating processes, gloss levels, substrates and textures. Similarly, special RAL, BS, wood effects or other colours will not be a precise match.

Colours shown are limited in accuracy by the printing process - samples should always be requested.

Wood Design frame legs, headers & 3D profiles in Night Oak & Rosewood are finished in a complimenting painted wood effect finish but will not match precisely. Golden Oak & Winchester are finished in a flat colour RAL 8014. TT9016 Bling White frame legs, headers & 3D profiles are finished in RAL 9016.

If you are matching to other finishes, particularly wood effects such as rosewood, golden oak, night oak or Winchester, always request a sample.

All frame legs, headers & 3D profiles are available in smooth finish only.



Doors can also be coloured to any RAL shade

Colours

| | | | |
|------------------------------------|-------------------------------|---|---|
| <input type="checkbox"/> | <input type="checkbox"/> | <input type="checkbox"/> | <input type="checkbox"/> |
| | | | |
| Flame Red RAL 3000 | Fir Green RAL 6009 | Moss Green RAL 6005 | Sepia Brown RAL 8014 |
| <input type="checkbox"/> | <input type="checkbox"/> | <input type="checkbox"/> | <input type="checkbox"/> |
| | | | |
| Window Grey RAL 7040 | Anthracite Grey RAL 7016 | White Aluminium RAL 9006 | Cream RAL 9001 |
| <input type="checkbox"/> | <input type="checkbox"/> | <input type="checkbox"/> | <input type="checkbox"/> |
| | | | |
| Quartz Grey RAL 7039 | Light Grey RAL 7035 | Grey Aluminium RAL 9007 | Jet Black RAL 9005 |
| <input type="checkbox"/> | <input type="checkbox"/> | <input type="checkbox"/> | <input type="checkbox"/> |
| | | | |
| White RAL 9016 | Umbra Grey RAL 7022 | Steel Blue RAL 5011 | Slate Grey RAL 7015 |
| <input type="checkbox"/> | <input type="checkbox"/> | <input type="checkbox"/> | <input type="checkbox"/> |
| | | | |
| Anthracite Textured RAL 7016 | Ice Crystal Grey Aluminium | TT703 satin metallic grey with micaceous iron ore particles | TT9016 Bling White with micaceous iron ore particles glitter effect |

Wood effects

See page 26

| | | | |
|-------------------------------------|-----------------------------------|------------------------------------|-------------------------------------|
| | | | |
| Golden Oak <input type="checkbox"/> | Rosewood <input type="checkbox"/> | Night oak <input type="checkbox"/> | Winchester <input type="checkbox"/> |



CarTeck Solid - Smooth White RAL 9016

Windows

| | |
|--|--|
| | |
| Rectangle 1 <input type="checkbox"/> | Rectangle 2 <input type="checkbox"/> |
| | |
| Cross Mullion <input type="checkbox"/> | Rhombus Mullion <input type="checkbox"/> |
| | |
| Square 1 <input type="checkbox"/> | Rectangle 3 <input type="checkbox"/> |
| | |
| Square 2 <input type="checkbox"/> | Aluminium light strip <input type="checkbox"/> |



The images above show popular window combinations. If you'd like alternative window configuration, just ask!
For extra special windows and decals, see our Bling section on pages 30 & 31.

Automation

| | |
|--|---|
| | |
| Ambience pack 1 <input type="checkbox"/> | Parking pack 1 <input type="checkbox"/> |
| Ambience pack 2 <input type="checkbox"/> | Parking pack 2 <input type="checkbox"/> |
| Ambience pack 3 <input type="checkbox"/> | |
| Ambience pack 4 <input type="checkbox"/> | Smart Pack <input type="checkbox"/> |
| | |
| Security pack 1 <input type="checkbox"/> | Access pack 1 <input type="checkbox"/> |
| Security pack 2 <input type="checkbox"/> | Access pack 2 <input type="checkbox"/> |
| | Access pack 3 <input type="checkbox"/> |
| Power Pack <input type="checkbox"/> | |
| | Pearl Vibe <input type="checkbox"/> |
| | |
| | Safety Pack <input type="checkbox"/> |

For pack details see page 12-13

The Style Master

Our most popular style. CarTeck Automatic's centre ribbed proportions give the door a refined designer feel that just works!

CarTeck Automatic Centre Ribbed



CarTeck Centre Rib - Grey Aluminium RAL 9007

Scan me to see more!



CarTeck Centre Ribbed - Smooth Jet Black RAL 9005

Surface Textures



Smooth



Woodgrain



Stucco

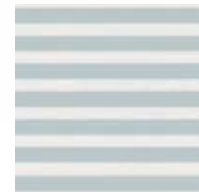

Micro-profiled

A note about colour

Where doors are exposed to direct sunlight, dark colours should be avoided.

RAL references for colours are provided as a guide only to the nearest similar RAL colour. Colours will not match to other RAL finishes due to different coating processes, gloss levels, substrates and textures. Similarly, special RAL, BS, wood effects or other colours will not be a precise match.

Colours shown are limited in accuracy by the printing process - samples should always be requested.

Wood Design frame legs, headers & 3D profiles in Night Oak & Rosewood are finished in a complimenting painted wood effect finish but will not match precisely. Golden Oak & Winchester are finished in a flat colour RAL 8014. TT9016 Bling White frame legs, headers & 3D profiles are finished in RAL 9016.

If you are matching to other finishes, particularly wood effects such as rosewood, golden oak, night oak or Winchester, always request a sample.

All frame legs, headers & 3D profiles are available in smooth finish only.



Doors can also be coloured to any RAL shade

Colours

| | | | |
|------------------------------------|-------------------------------|---|---|
| <input type="checkbox"/> | <input type="checkbox"/> | <input type="checkbox"/> | <input type="checkbox"/> |
| | | | |
| Flame Red RAL 3000 | Fir Green RAL 6009 | Moss Green RAL 6005 | Sepia Brown RAL 8014 |
| <input type="checkbox"/> | <input type="checkbox"/> | <input type="checkbox"/> | <input type="checkbox"/> |
| | | | |
| Window Grey RAL 7040 | Anthracite Grey RAL 7016 | White Aluminium RAL 9006 | Cream RAL 9001 |
| <input type="checkbox"/> | <input type="checkbox"/> | <input type="checkbox"/> | <input type="checkbox"/> |
| | | | |
| Quartz Grey RAL 7039 | Light Grey RAL 7035 | Grey Aluminium RAL 9007 | Jet Black RAL 9005 |
| <input type="checkbox"/> | <input type="checkbox"/> | <input type="checkbox"/> | <input type="checkbox"/> |
| | | | |
| White RAL 9016 | Umbra Grey RAL 7022 | Steel Blue RAL 5011 | Slate Grey RAL 7015 |
| <input type="checkbox"/> | <input type="checkbox"/> | <input type="checkbox"/> | <input type="checkbox"/> |
| | | | |
| Anthracite Textured RAL 7016 | Ice Crystal Grey Aluminium | TT703 satin metallic grey with micaceous iron ore particles | TT9016 Bling White with micaceous iron ore particles glitter effect |

Wood effects

See page 26

| | | | |
|-------------------------------------|-----------------------------------|------------------------------------|-------------------------------------|
| | | | |
| Golden Oak <input type="checkbox"/> | Rosewood <input type="checkbox"/> | Night oak <input type="checkbox"/> | Winchester <input type="checkbox"/> |



CarTeck Centre Ribbed - Smooth Wood Effect Golden Oak

Windows

| | |
|--|--|
| | |
| Rectangle 1 <input type="checkbox"/> | Rectangle 2 <input type="checkbox"/> |
| | |
| Cross Mullion <input type="checkbox"/> | Rhombus Mullion <input type="checkbox"/> |
| | |
| Square 1 <input type="checkbox"/> | Rectangle 3 <input type="checkbox"/> |
| | |
| Square 2 <input type="checkbox"/> | Aluminium light strip <input type="checkbox"/> |



The images above show popular window combinations. If you'd like alternative window configuration, just ask!

For extra special windows and decals, see our Bling section on pages 30 & 31.

Automation

| | |
|--|---|
| | |
| Ambience pack 1 <input type="checkbox"/> | Parking pack 1 <input type="checkbox"/> |
| Ambience pack 2 <input type="checkbox"/> | Parking pack 2 <input type="checkbox"/> |
| Ambience pack 3 <input type="checkbox"/> | |
| Ambience pack 4 <input type="checkbox"/> | Smart Pack <input type="checkbox"/> |
| | |
| Security pack 1 <input type="checkbox"/> | Access pack 1 <input type="checkbox"/> |
| Security pack 2 <input type="checkbox"/> | Access pack 2 <input type="checkbox"/> |
| | Access pack 3 <input type="checkbox"/> |
| Power Pack <input type="checkbox"/> | |
| | Pearl Vibe <input type="checkbox"/> |
| | |
| | Safety Pack <input type="checkbox"/> |

For pack details see page 12-13

Simple, Timeless

Horizontal rib styling is wonderfully simple way to create a design that is at home on any style of house, choose white, wood effect or add a splash of colour!

CarTeck Automatic Standard Ribbed



CarTeck Standard Ribbed- White RAL 9016

Scan me to see more!



CarTeck Standard Ribbed - Smooth White RAL 9016

Surface Textures

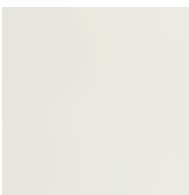

Smooth



Woodgrain



Stucco

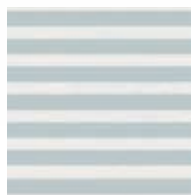

Micro-profiled

A note about colour

Where doors are exposed to direct sunlight, dark colours should be avoided.

RAL references for colours are provided as a guide only to the nearest similar RAL colour. Colours will not match to other RAL finishes due to different coating processes, gloss levels, substrates and textures. Similarly, special RAL, BS, wood effects or other colours will not be a precise match.

Colours shown are limited in accuracy by the printing process - samples should always be requested.

Wood Design frame legs, headers & 3D profiles in Night Oak & Rosewood are finished in a complimenting painted wood effect finish but will not match precisely. Golden Oak & Winchester are finished in a flat colour RAL 8014. TT9016 Bling White frame legs, headers & 3D profiles are finished in RAL 9016.

If you are matching to other finishes, particularly wood effects such as rosewood, golden oak, night oak or Winchester, always request a sample.

All frame legs, headers & 3D profiles are available in smooth finish only.



Doors can also be coloured to any RAL shade

Colours

| | | | |
|------------------------------------|-------------------------------|---|---|
| <input type="checkbox"/> | <input type="checkbox"/> | <input type="checkbox"/> | <input type="checkbox"/> |
| | | | |
| Flame Red RAL 3000 | Fir Green RAL 6009 | Moss Green RAL 6005 | Sepia Brown RAL 8014 |
| <input type="checkbox"/> | <input type="checkbox"/> | <input type="checkbox"/> | <input type="checkbox"/> |
| | | | |
| Window Grey RAL 7040 | Anthracite Grey RAL 7016 | White Aluminium RAL 9006 | Cream RAL 9001 |
| <input type="checkbox"/> | <input type="checkbox"/> | <input type="checkbox"/> | <input type="checkbox"/> |
| | | | |
| Quartz Grey RAL 7039 | Light Grey RAL 7035 | Grey Aluminium RAL 9007 | Jet Black RAL 9005 |
| <input type="checkbox"/> | <input type="checkbox"/> | <input type="checkbox"/> | <input type="checkbox"/> |
| | | | |
| White RAL 9016 | Umbra Grey RAL 7022 | Steel Blue RAL 5011 | Slate Grey RAL 7015 |
| <input type="checkbox"/> | <input type="checkbox"/> | <input type="checkbox"/> | <input type="checkbox"/> |
| | | | |
| Anthracite Textured RAL 7016 | Ice Crystal Grey Aluminium | TT703 satin metallic grey with micaceous iron ore particles | TT9016 Bling White with micaceous iron ore particles glitter effect |

Wood effects

See page 26

| | | | |
|-------------------------------------|-----------------------------------|------------------------------------|-------------------------------------|
| | | | |
| Golden Oak <input type="checkbox"/> | Rosewood <input type="checkbox"/> | Night oak <input type="checkbox"/> | Winchester <input type="checkbox"/> |



CarTeck Standard Ribbed - Smooth Wood Effect Rosewood

Windows

| | |
|--|--|
| | |
| Rectangle 1 <input type="checkbox"/> | Rectangle 2 <input type="checkbox"/> |
| | |
| Cross Mullion <input type="checkbox"/> | Rhombus Mullion <input type="checkbox"/> |
| | |
| Square 1 <input type="checkbox"/> | Rectangle 3 <input type="checkbox"/> |
| | |
| Square 2 <input type="checkbox"/> | Aluminium light strip <input type="checkbox"/> |



The images above show popular window combinations. If you'd like alternative window configuration, just ask!

For extra special windows and decals, see our Bling section on pages 30 & 31.

Automation

| | |
|--|---|
| | |
| Ambience pack 1 <input type="checkbox"/> | Parking pack 1 <input type="checkbox"/> |
| Ambience pack 2 <input type="checkbox"/> | Parking pack 2 <input type="checkbox"/> |
| Ambience pack 3 <input type="checkbox"/> | |
| Ambience pack 4 <input type="checkbox"/> | Smart Pack <input type="checkbox"/> |
| | |
| Security pack 1 <input type="checkbox"/> | Access pack 1 <input type="checkbox"/> |
| Security pack 2 <input type="checkbox"/> | Access pack 2 <input type="checkbox"/> |
| | Access pack 3 <input type="checkbox"/> |
| Power Pack <input type="checkbox"/> | |
| | Pearl Vibe <input type="checkbox"/> |
| | |
| | Safety Pack <input type="checkbox"/> |

For pack details see page 12-13

The Classic

The Georgian design features are a timeless favourite and work beautifully with the addition of windows for an added accent and natural light.

CarTeck Automatic Georgian



CarTeck Georgian - White RAL 9016 with Cross Mullion Windows

Scan me to see more!



CarTeck Georgian - Woodgrain Jet Black RAL 9005

Surface Textures



Woodgrain

A note about colour

Where doors are exposed to direct sunlight, dark colours should be avoided.

RAL references for colours are provided as a guide only to the nearest similar RAL colour. Colours will not match to other RAL finishes due to different coating processes, gloss levels, substrates and textures. Similarly, special RAL, BS, wood effects or other colours will not be a precise match.

Colours shown are limited in accuracy by the printing process - samples should always be requested.

Wood Design frame legs, headers & 3D profiles in Night Oak & Rosewood are finished in a complimenting painted wood effect finish but will not match precisely. Golden Oak & Winchester are finished in a flat colour RAL 8014. TT9016 Bling White frame legs, headers & 3D profiles are finished in RAL 9016.

If you are matching to other finishes, particularly wood effects such as rosewood, golden oak, night oak or Winchester, always request a sample.

All frame legs, headers & 3D profiles are available in smooth finish only.



Doors can also be coloured to any RAL shade

Colours

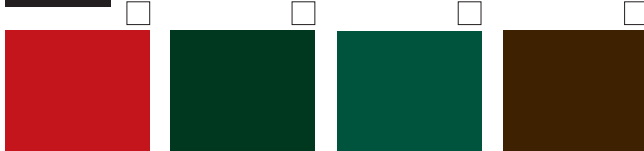

Flame Red
RAL 3000

Fir Green
RAL 6009

Moss Green
RAL 6005

Sepia Brown
RAL 8014



Window Grey
RAL 7040

Anthracite
Grey RAL 7016

White Aluminium
RAL 9006

Cream
RAL 9001



Quartz Grey
RAL 7039

Light Grey
RAL 7035

Grey Aluminium
RAL 9007

Jet Black
RAL 9005



White
RAL 9016

Umbra Grey
RAL 7022

Steel Blue
RAL 5011

Slate Grey
RAL 7015



Anthracite
Textured
RAL 7016

Ice Crystal Grey
Aluminium

TT703 satin
metallic grey
with micaceous
iron ore
particles

TT9016 Bling
White with
micaceous iron
ore particles
glitter effect

Wood effects

See page 26



Golden Oak

Rosewood

Night oak

Winchester



Carteck Georgian - Woodgrain White RAL 9016

Windows



Rectangle 1



Cross Mullion



Rhombus Mullion

Automation



Parking pack 1
Parking pack 2



Ambience pack 1
Ambience pack 2
Ambience pack 3
Ambience pack 4



Smart Pack



Access pack 1
Access pack 2
Access pack 3



Security pack 1
Security pack 2



Pearl Vibe

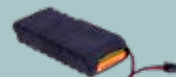

Power Pack



Safety Pack

For pack details see page 12-13

Rich woodtones

Our wide grain wood effect finishes are grained to give a much more natural look than close grain finishes.

CarTeck Automatic Wood Effect



Scan me to see more!



CarTeck Georgian - Woodgrain Wood Effect Golden Oak

Surface Texture for Georgian



Woodgrain

Life-like Wood effect

Our wood effect doors definitely look the part - characterful woodgraining brings these designs to life.

A note about colour

Where doors are exposed to direct sunlight, dark colours should be avoided.

RAL references for colours are provided as a guide only to the nearest similar RAL colour. Colours will not match to other RAL finishes due to different coating processes, gloss levels, substrates and textures. Similarly, special RAL, BS, wood effects or other colours will not be a precise match.

Colours shown are limited in accuracy by the printing process - samples should always be requested.

Wood Design frame legs, headers & 3D profiles in Night Oak & Rosewood are finished in a complimenting painted wood effect finish but will not match precisely. Golden Oak & Winchester are finished in a flat colour RAL 8014.

If you are matching to other finishes, particularly wood effects such as rosewood, golden oak, night oak or Winchester, always request a sample.

All frame legs, headers & 3D profiles are available in smooth finish only.

Wood effects



Golden Oak Rosewood Night oak Winchester

Centre Rib Rosewood



Centre Rib Golden Oak



Surface Textures for Standard Rib, Centre Rib & Solid



Smooth Rosewood & Night Oak Smooth Golden Oak

Better scratch resistance & UV stability

These woodgrains are a paint finished surface instead of the traditional surface bonded film. They outperform films for scratch resistance. The paint finish is also more UV stable over time, retaining colour for longer and less prone to the finish becoming "milky" in strong sunlight.

Solid Night Oak



Solid Winchester





Scratch-resistant Polymer
Double Pane
Clear



Scratch-resistant Polymer
Double Pane
Frosted



Scratch-resistant Polymer
Double Pane
Satin

Our glazing elements.

Glazing Elements

Scratch-resistant Polymer, double glazed windows in attractive designs allow natural light into your garage.

As harmonious integration or intentional contrast – aligned with other facades and windows, vision elements play a key role in shaping the overall architecture of your house.



Window frames are coloured to be similar to the door panel. Selected Trend colours & wood design windows are finished in a complementary flat colour for Golden Oak (RAL8003), Rosewood (RAL8016), Night Oak (RAL8014), Winchester (RAL8001), Textured Anthracite (RAL7016), Ice Crystal Grey Aluminium (RAL9007) and TT9016 Bling White (RAL9016). The surrounds on aluminium GSA window sections are finished in a smooth finish.

Window frame colour shade and surface lustre will show a variance from the panel finish as the base material and coating methods are different.



Rectangle 1



Rectangle 2*



Cross mullion



Rhombus Mullion



Square 1*



Rectangle 3*



Square 2*



GSA Aluminium light strip

*Not available on Georgian style

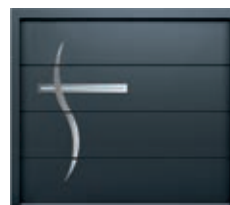

The images above show popular window combinations. If you'd like alternative window configuration, just ask!

For extra special windows and decals, see our Bling section on pages 30 & 31.

Teckentrup Bling!

Available on:



CarTeck Automatic Solid



CarTeck Automatic Centre Ribbed



CarTeck Automatic Standard Ribbed

Bling Windows

Windows

High-grade window units add natural daylight with a contemporary twist. Windows are constructed with an aluminium casement and polymer glazing unit.

Glazing Styles



Satin



Clear

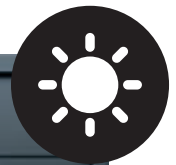

Athena
406mm x 203mm



Versus
900mm x 1000mm

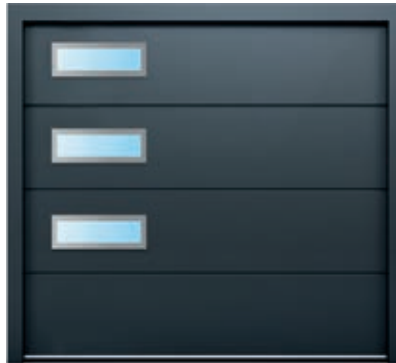

Sigma
610mm x 200mm

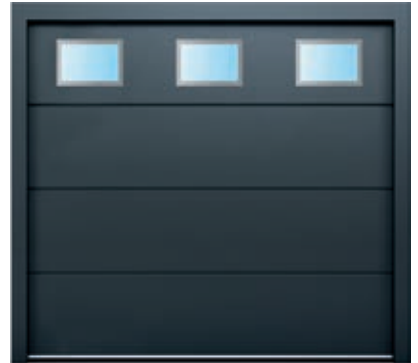

Gamma
534mm x 344mm



Zeta
ø280mm

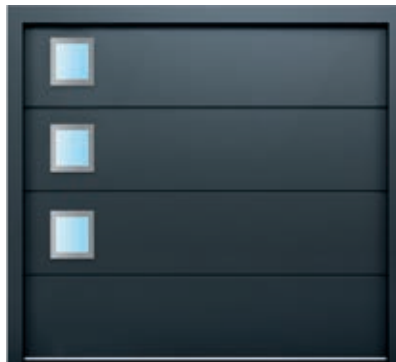

Alpha
280mm x 280mm

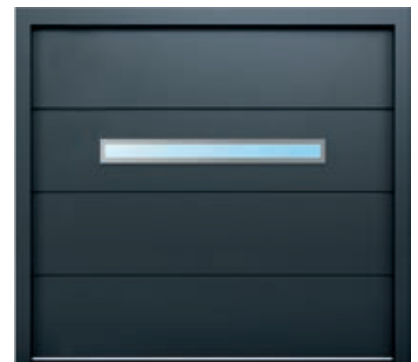

Kappa
1860mm x 180mm

More!

Extras

Finishing touches to make your door easier to use.



LETTER BOXES



SPY HOLES



PET FLAPS

Pet Flaps, usually fitted to the bottom panel of a door!



ANYTHING ELSE?

If you can think of anything else you would like to incorporate onto your door, just ask and we'll see if we can make it happen!

Design Accents

Decals

High-grade alinox decals are factory bonded to your door for added visual appeal. Each decal can be positioned to suit your sense of design, however, popular arrangements are shown here.

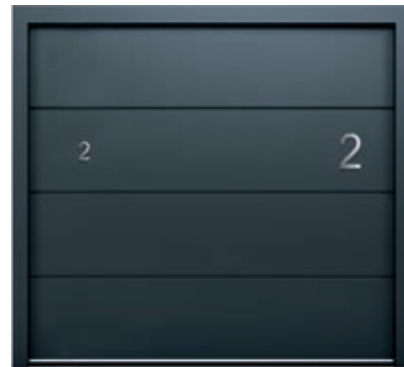

Writing
100mm/200mm

Decorative Decal Options

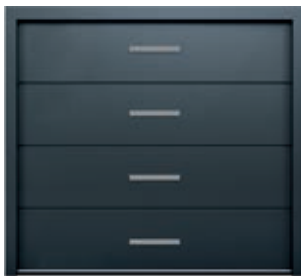

Access 1
431mm x 40mm

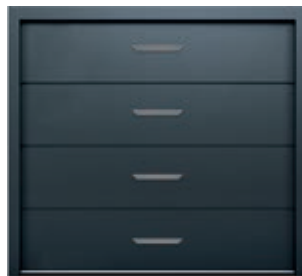

Access 2
430mm x 40mm

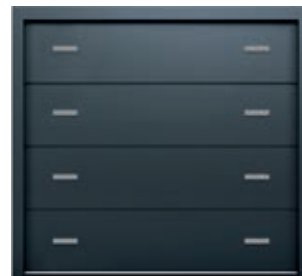

Access 3
215mm x 40mm

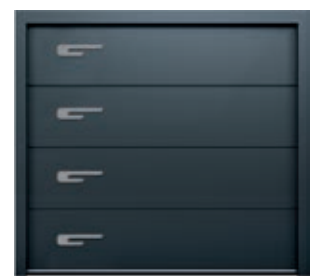

Access 4
400mm x 86mm

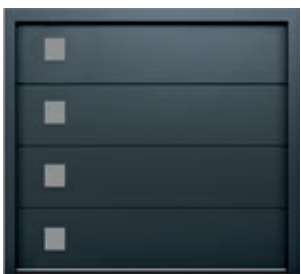

Access 5
180mm x 180mm

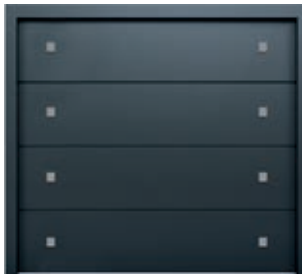

Access 6
70mm x 70mm

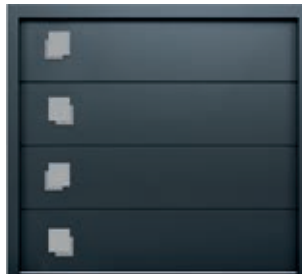

Access 7
150mm x 150mm

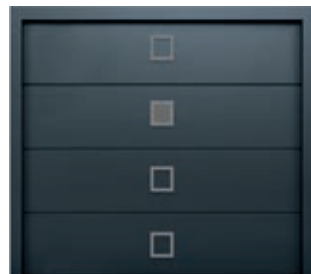

Access 8
194 mm x 194 mm

The images above and left show the most popular combinations. If you'd like alternative configuration, just ask!

SLX Vision

For a panoramic presence look no further than the CarTeck SLX Vision. The doors employ the same market-leading sectional lifting gear used on the standard CarTeck range with its concealed lifting springs, but with added wow-factor.

These automated doors have full width vision panels made from 40mm hollow aluminium profiles, with 20mm scratch resistant, polymer double glazing in a choice of six vision styles.



WHAT PERFORMANCE CAN I EXPECT?

As part of the CE marking process, each product must have its performance provided for a defined set of characteristics to allow fair comparison between products from different manufacturers. Other characteristics can also be included, if relevant to a door's performance. The following tables show the performance characteristics of CarTeck SLX Vision sectional garage doors.

SLX VISION PERFORMANCE CHARACTERISTIC

RATING

| | |
|--|------------------------|
| Resistance to Windload EN 12424 | Class 2 |
| Watertightness EN 12425 | Class 2 |
| Air Permeability EN 12426 | Class 2 |
| Thermal Transmittance EN 13241 | 3.5 W/m ² k |
| Operating Forces (hand Operated) EN 12604 | 150 N |

VISION OPTIONS

Windows are made from double pane scratch-resistant polymer.



Clear



Satin



Frosted



Green Tint
70% transmission
(approx)



Brown Tint
50% transmission
(approx)



Grey Tint
43% transmission
(approx)

COLOURS



Flame Red
RAL 3000



Fir Green
RAL 6009



Moss Green
RAL 6005



Sepia Brown
RAL 8014



Window Grey
RAL 7040



Anthracite
Grey RAL 7016



White Aluminium
RAL 9006

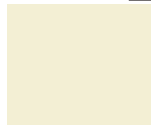

Cream
RAL 9001

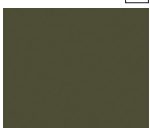

Quartz Grey
RAL 7039



Light Grey
RAL 7035



Grey Aluminium
RAL 9007



Jet Black
RAL 9005

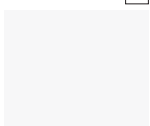

White
RAL 9016

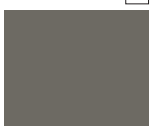

Umbra Grey
RAL 7022



Steel Blue
RAL 5011



Slate Grey
RAL 7015

A NOTE ABOUT COLOUR

Where doors are exposed to direct sunlight, dark colours should be avoided. RAL references for colours are provided as a guide only to the nearest similar RAL colour. Colours will not match to other RAL finishes due to different coating processes, gloss levels, substrates and textures. Similarly, special RAL, BS or other colours will not be a precise match.

Colours shown are limited in accuracy by the printing process - samples should always be requested.

All frame legs, headers & 3D profiles are available in smooth finish only.

WHAT WILL MY DOOR LOOK LIKE?

Full width glazing up to 3250mm wide (no mullions)



Single mullion over 3250mm wide, maximum width 4000mm.



The number of sections is dependent on door height and is shown below:



4 sections
Doors up to 2280mm high.



5 sections
Doors up to 2835mm high.



6 sections
Doors up to 3000mm high.



Our doors and openers are independently tested and certified to all current safety legislation and carry a CE mark.

GSA Vision

Multiple mullions give the CarTeck GSA Vision an ultra-contemporary, minimalist aesthetic. Choose privacy and light with satin or frosted glazing.

These automated doors have sections made from 40mm hollow aluminium profiles, with 20mm scratch resistant, polymer double glazing. The doors also employ the same market-leading sectional lifting gear used on the standard CarTeck range with its concealed lifting springs and quiet smooth action.



Matching side doors available.



WHAT PERFORMANCE CAN I EXPECT?

As part of the CE marking process, each product must have its performance provided for a defined set of characteristics to allow fair comparison between products from different manufacturers. Other characteristics can also be included, if relevant to a door's performance. The following tables show the performance characteristics of CarTeck GSA Vision sectional garage doors.

GSA VISION PERFORMANCE CHARACTERISTIC

RATING

| | |
|---|------------------------|
| Resistance to Windload EN 12424 | Class 2 |
| Watertightness EN 12425 | Class 2 |
| Air Permeability EN 12426 | Class 2 |
| Thermal Transmittance EN 13241 | 3.3 W/m ² k |
| Operating Forces (hand Operated) EN 12604 | 150 N |

VISION OPTIONS

Windows are made from double pane scratch-resistant polymer.



Clear Satin Frosted

COLOURS



A NOTE ABOUT COLOUR

Where doors are exposed to direct sunlight, dark colours should be avoided. RAL references for colours are provided as a guide only to the nearest similar RAL colour. Colours will not match to other RAL finishes due to different coating processes, gloss levels, substrates and textures. Similarly, special RAL, BS or other colours will not be a precise match. Colours shown are limited in accuracy by the printing process - samples should always be requested. All frame legs, headers & 3D profiles are available in smooth finish only.

WHAT WILL MY DOOR LOOK LIKE?

The number of vertical mullions is dependent on door width and is shown below:

Doors up to 2235mm wide

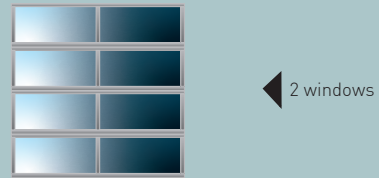

Doors up to 2438mm wide



Doors up to 3353mm wide



Doors up to 4420mm wide



Doors up to 5500mm wide

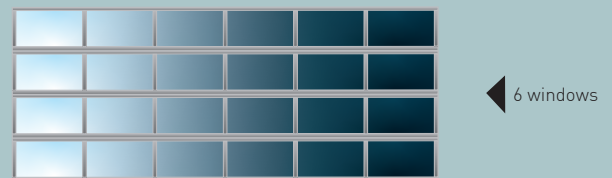

The number of sections is dependent on door height and is shown below:

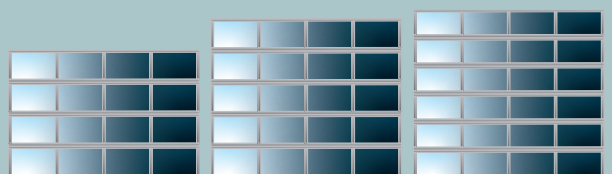

4 sections

Doors up to
2280mm high.

5 sections

Doors up to
2835mm high.

6 sections

Doors up to
3000mm high.



Our doors and openers are independently tested and certified to all current safety legislation and carry a CE mark.

CarTeck Side Hinged Garage Doors & Side Doors



CarTeck Centre Ribbed Smooth - Jet Black with standard lipped threshold



Window options are also available on CarTeck Side Hinged garage doors. See the CarTeck Side Hinged Garage Door & Side Doors Brochure for full details.



Styles are available as 1/2 and 1/2 split (shown above) or as an asymmetric design (shown left).

1/2 and 1/2 split

Asymmetric

Georgian Horizontal



Georgian Vertical



Solid Vertical



Solid Horizontal



Centre Ribbed Vertical



Centre Ribbed Horizontal



Standard Ribbed Vertical



Standard Ribbed Horizontal



Traditional Standard Ribbed Vertical



Traditional Centre Ribbed Horizontal



Each of the Traditional designs is also available in centre ribbed and solid panel profiles. Traditional Doors are supplied with mock leaded-effect windows as standard. Plain windows are also available.

To see all design variants available request or download the CarTeck Side Hinged Garage Door & Side Doors Brochure.

CarTeck Side Hinged Garage Door & Side Doors are available in a wide range of colours - see page 19 or 21, 23, and 25.

Simply the best

Teckentrup side hinged garage doors and personnel doors are quite simply the very best. The solid panels, engineered hollow section aluminium frames and high grade fittings result in a door that closes with a reassuringly deep "clunk".

Security is excellent and the range of styles, finishes and windows allows personalisation to suit your tastes. 1/2 and 1/2 opening and asymmetric configurations further increase the doors' versatility.

Neat inside too

The inside of the door is very presentable. There are no unsightly bracings just a wipe clean surface finished in a practical grey white stucco texture (RAL 9002). Horizontal doors are as shown below, vertical doors have small jointing plates at the panel interfaces



EN 13241

Our doors are independently tested and certified to all current safety legislation and carry a CE mark.



To see the full range...

Ask for the CarTeck Side Hinged Garage Door & Side Doors Brochure or download a copy from the Teckentrup website.

TECKENTRUP
DOOR SOLUTIONS

Teckentrup is a family business with operations throughout the world. In the UK we make our garage doors in Warrington, Cheshire. CarTeck Automatic is available through a national network of independent Garage Door Specialist installers.

Teckentrup offers more than garage doors: We provide solutions and have set three quality standards for our garage doors:

Design.

Security.

Service.

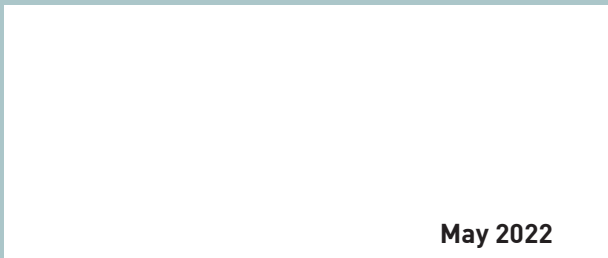

May 2022

Teckentrup UK Limited, Units 2-4 Opus 9 Industrial Estate,
Woburn Road, Winwick Quay, Warrington WA2 8UE

t: 01925 924 050

f: 08701 314 843

e: sales@teckentrup.co.uk

TECKENTRUP
DOOR SOLUTIONS

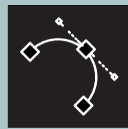

Design

We combine ease of use with aesthetics.

Good design uses innovative technology to make using a product intuitive and effortless. CarTeck Automatic sectional garage doors offer a wide range of design options that will transform the look of your home and the way you use your garage space.



Safety & Security

We combine security with safety.

Our products are designed to provide peace of mind with both physical security and the knowledge that durability and safe operation are inherent.



Service

We combine speed with reliability.

The Teckentrup team and our network of Garage Door Specialists installers love to make your new door a pleasure to own. From planning to installation. You'll always receive expert advice and the best service for installation, maintenance and aftercare.

Quality & Environment

Teckentrup operates to quality procedures audited to ISO 9001. We care about the environment too - this is why our products are certified in accordance with the Environmental Product Declaration (EPD).

ISO 14001 Environmental Management

ISO 50001 Energy Management



Raising Standards
Safety Assured

Member



CONTRACTORS HEALTH & SAFETY ASSESSMENT SCHEME
Accredited Contractor
www.chas.co.uk



LPCB
Red Book
LPCB